

A red Ramfire fire truck is shown from a front-three-quarter view, driving on a city street at night. The truck's emergency lights, including a long light bar on the roof and auxiliary lights on the front bumper, are flashing in red, blue, and white. The truck has a prominent chrome grille and a fire department emblem on the side. The background is a blurred city street with buildings and streetlights.

RAMFIRE[®]
FIRE RESCUE CATALOG VOL.54

FIRE RESCUE CATALOG

BATTERY | ELECTRIC | GAS | WATER

CONTENTS

3 CORE TECHNOLOGIES

7 ADVANCED SAFETY FEATURES

11 BrushlessPPV™ FAMILY

21 KRAKEN//instagrid

23 PLUG-IN ELECTRIC PPV BLOWERS

27 GAS PPV BLOWERS

31 WATER PPV BLOWERS

35 LARGE STRUCTURE VENTILATORS

39 ELECTRIC CONFINED SPACE FANS

45 CERTIFICATES & STANDARDS

47 SERVICES



CORE TECHNOLOGIES

PURPOSE BUILT - POWER TO SERVE

Battery Safety

PRO//connect

BrushlessPPV™

Advanced Safety Features

MAX mode

Variable Input Power Management

Active Risk Control

PowerStream®



BATTERY SAFETY

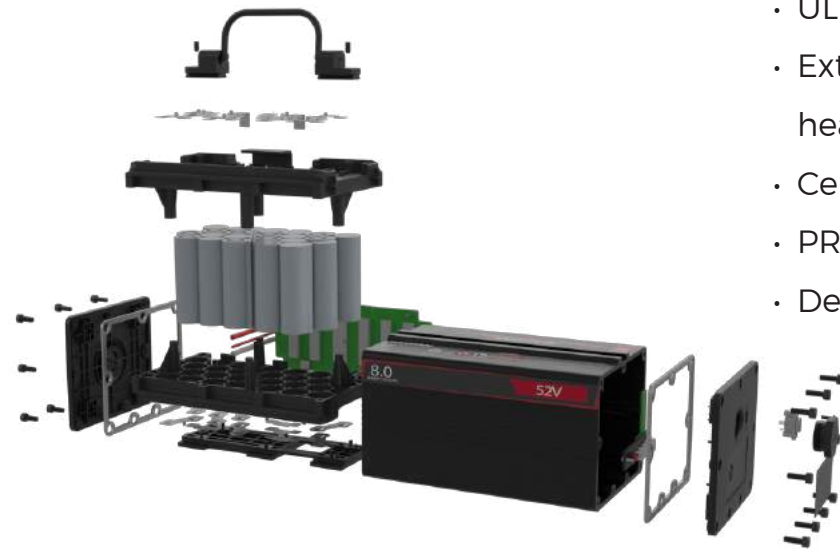

- UL 94 V-0 Flameproof plastics
- Extruded aluminum housing 360° heat sink
- Cell level diagnostics
- PRO//connect compatibility
- Depressurization Valve

MAINTENANCE PROCEDURE

BATTERY PACK	AFTER EACH USE	MONTHLY	EVERY YEAR
Gaskets	Inspect	Inspect	Inspect
External Connections	Inspect		
PRO//connect Diagnostics			Inspect
Discharge & Recharge		Inspect	



40V & 52V Compatibility

PRO//CONNECT

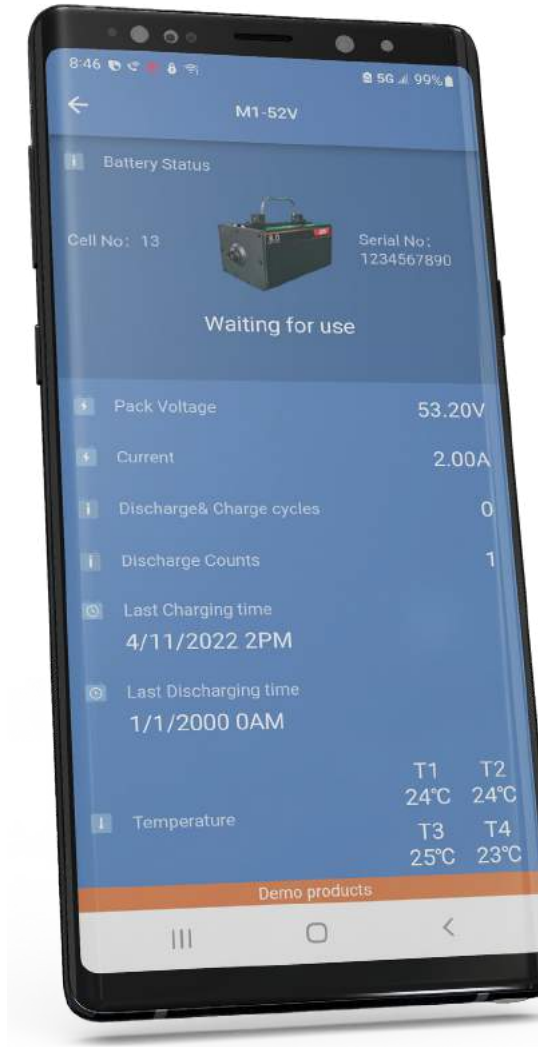

Bluetooth™

INTELLIGENT FUNCTIONS

- Maintenance Mode
- Recycle Mode

AVAILABLE DATA

- Charge Cycles
- State of Health
- State of Charge
- Temperature Sensors
- Cell Voltage
- Date of Last Charge
- Fault Code Reader



PRO//connect Compatibility

MODEL	CAPACITY	POWER	PERFORMANCE
R2-40V	6 Ah	216 Wh	500 cycles
M1-52V	8 Ah	375 Wh	500 cycles



BRUSHLESSPPV™



- Continuous Duty
- Greater than 90% efficiency
- TAE0 Design
- Ultra lightweight
- Optimized for firefighting PPV use

BrushlessPPV™ Models

PLATFORM	CONTROLLER	APPLICATION	CLASS
18V	Intellisense S1	Battery-Electric PPV	1 hp
42V	Intellisense E2		2 hp
52V	Intellisense E3		3 hp
400V	Intellisense P1	Plug-In Electric PPV	3 hp



ADVANCED SAFETY FEATURES

MAX MODE

1, 2, GO!



- Simple, intuitive operation
- Short-cut to maximum power
- Single button press

AVAILABLE ON
All BrushlessPPV™ Fans

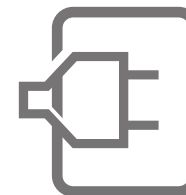

VARIABLE INPUT POWER MANAGEMENT SYSTEM

- Variable Input Power Management System
- Maximize the performance based on available power source
- Auto detection of input power: battery & AC circuits
- Optimize for performance, safety & durability



AVAILABLE ON
40V and 52V BrushlessPPV™ Fans



POWERSTREAM®

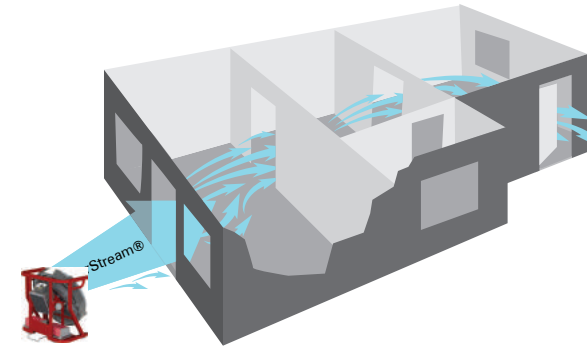

- RAMFAN proprietary air straightener technology
- Allows for greater the setback, using air entrained
- Increases the total air volume going into a structure
- Advanced fan impeller design converts a wide, spinning mass of air into a straight, focused beam

AVAILABLE ON
EX, GX, WX Models

ACTIVE RISK CONTROL



- Detect abrupt, unsafe fan movements
- Auto shutdown of fan to prevent injury
- Embedded sensor detection
- Safety technology built into all BrushlessPPV fans

AVAILABLE ON
All BrushlessPPV™ Fans



BrushlessPPV™ FAMILY

RAMFAN's unique ecosystem of PPV fans designed exclusively for firefighting, providing the highest power available at the fireground.



18V



40V



52V



400V



18V for small flow desmoking of rooms or small residential structures—compatible with the commercial batteries of your extrication and handheld power tools

- Use the batteries and chargers you already have in service.

SPECS

ORDER# EL5518D/EL5518M	RAMFAN 18V
MOTOR	1 hp BrushlessPPV™
RUNTIME AT FULL SPEED	Depends on battery size
BATTERY COMPATABILITY	18V Lithium-Ion Milwaukee M18 DeWALT 18V/20V FLEXVOLT
IP RATING	IP66 (Fan only)
WEIGHT	50 lbs
DIMENSIONS (H X W X D)	22" x 21" x 12"
AMPS	6.7A (115V), 3.8A (230V)
APPROVALS	
NOMINAL DIAMETER	18"
CONTROLLER PLATFORM	Intellisense S1
AMCA 240-15 VERIFIED AIRFLOW	
BATTERY POWER	10,120 cfm

Intellisense S1

DC/DC Battery-in-Series (BIS) Controller
18V / 36V

AC/DC Power Conversion
700W

BrushlessPPV™
Motor Controller
36V-16A

System Diagnostics

Accessory Power



40V

Intellisense E2

BrushlessPPV™
Motor Controller
48V



AC/DC Power Conversion **700W**

System
Diagnostics



(BMS)

Battery Management
System

Accessory Power





AC/DC
Battery Charger



AC/DC
Battery Charger

SPECS

ORDER# EL5500-2PK	Includes RAMFAN 40V 6Ah battery packs (2), power cord (1), carrying strap (1), wheel kit assembled (1)
MOTOR	1 hp BrushlessPPV™
RUNTIME AT FULL SPEED	45 minutes (two battery packs) Unlimited (AC)
BATTERY COMPATABILITY	RAMFAN 40V (2 simultaneously)
IP RATING	IP66
WEIGHT	54 lbs
DIMENSIONS (H X W X D)	22" x 21" x 12"
AMPS	6.7A (115V), 3.8A (230V)
NOISE	87 dB
APPROVALS	  UN 38.3 IEC 62133-2
NOMINAL DIAMETER	18"
CONTROLLER PLATFORM	Intellisense E2
ON-TOOL CHARGING	1.5A per battery, simultaneous charge
AMCA 240-15 VERIFIED AIRFLOW	
BATTERY POWER	10,120 cfm

52V



Intellisense E3

BrushlessPPV™
Motor Controller
56V



AC/DC Power Conversion **1400W**

PRO//Connect
System
Diagnostics



(BMS)

Battery Management
System

Accessory Power





AC/DC
Battery Charger



AC/DC
Battery Charger

SPECS

ORDER# EL6525 2PK	Includes RAMFAN 52V 8Ah battery packs (2), power cord (1), wheel kit assembled (1)
MOTOR	2 hp BrushlessPPV™
RUNTIME AT FULL SPEED	45 minutes (two battery packs) Unlimited (AC)
BATTERY COMPATABILITY	RAMFAN 52V (2 simultaneously)
IP RATING	IP66
WEIGHT	63 lbs
DIMENSIONS (H X W X D)	23" x 21" x 21"
AMPS	Under testing
NOISE	90.2 dB
APPROVALS	  UN 38.3 IEC 62133-2
NOMINAL DIAMETER	18"
CONTROLLER PLATFORM	Intellisense E3
ON-TOOL CHARGING	1.5A per battery, simultaneous charge
AMCA 240-15 VERIFIED AIRFLOW	
BATTERY POWER	12,377 cfm

400V



EXTREME POWER IN A LITE-WEIGHT PORTABLE PLATFORM.

400V/2.4kW for high flow vent tactics in larger structures and/or more aggressive tactics.



*EX550 is compatible with KRAKEN//instagrid (see pg.21 for more details)



SPECS

ORDER# EK90500/ EK90520	Includes RAMFAN 400V
MOTOR	3 hp BrushlessPPV™
RUNTIME AT FULL SPEED	40 minutes
WEIGHT	54 lbs
DIMENSIONS (H X W X D)	22" x 21" x 12"
AMPS	14A (115V), 10A (230V)
POWER SOURCE	AC grid portable generator, portable battery pack
NOMINAL DIAMETER	18"
CONTROLLER PLATFORM	Intellisense P1

Intellisense P1

BrushlessPPV™
Motor Controller
400V-6A

AC
Power Conversion
1600W (115V)
2400W (230V)

System Diagnostics

Accessory Power

ACCESSORIES

**Simultaneous Fast Charger**

Order# R25515
Order# R25515DC

Order # M16515DC
Order # M16515

**LED Light Upgrade Kit**

Call for details
(Compatible with 18V
BrushlessPPV model)

**Shoulder Strap**

Order# EL6013
Compatible with 18V, 40V,
and 400V BrushlessPPV
models

**PRO/connect Battery Packs**

Order # M1-52V
Order# R2-40V
Recommend purchasing 2

**Vehicle Mount**

Order# EL600K
(18V, 40V, 400V BrushlessPPV
models)

Order# EL610K
(52V BrushlessPPV model)

**Door Bar Hanger and Kit**

Order# EL7095
(Compatible with 18V, 40V,
and 400V BrushlessPPV
models)

Order# EL8095
Hanger Kit

**Standard Duct with Storage Bags**

Order# FDT-185MSR
18" / 46 cm x 16.4" / 5 m
(Compatible with 18V, 40V, 52V,
and 400V BrushlessPPV models)

Order# BG16
Storage Bag Only
Storage Bag for 16" (40 cm)

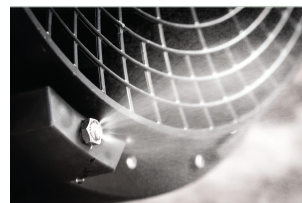
**Integrated Misters**

Order# EL8111
(Compatible with 18V, 40V,
52V, and 400V BrushlessPPV
models)

**HI-Expansion Foam Adapter**

Order# HI-5000
(Compatible with 18V, 40V,
52V, and 400V BrushlessPPV
models)



KRAKEN//instagrid

THE WORLD'S MOST ADVANCED PORTABLE POWER STATION FOR FIRST RESPONDERS

Introducing a portable power supply, combining continuous high output AC with ultra high pulse output--up to 10 kW--for powering professional tools and entire front line operations. We bring electricity with zero local emissions anywhere you might need it. Finally, a zero-emission solution for today's high power rescue equipment and future-proof preparedness for tomorrow.

- Save time and effort
- Carry electricity easily with you
- Minimise cabling to reduce tripping hazards
- Work indoors and outdoors - in any weather conditions
- Delivers power equivalent to 120 VAC / 30A household supply
- Use any AC electric equipment, no additional inverters needed
- Simple recharge through standard plug in 2.5 hours

PARAMETER	VALUE
Battery Capacity	2.074 Wh
Weight	44 lbs
Dimensions	16.53 x 8.26 x 16.53 in
IP Class	IP54+
Protection Class	Class II / double insulated
Noise Emission	< 10 dB(A)
Storage	> 3 years
Output	120 VAC
Continuous Output	3,600 W
Pulse Output (<5s)	10,000 W
Charge Time	2.5 hours

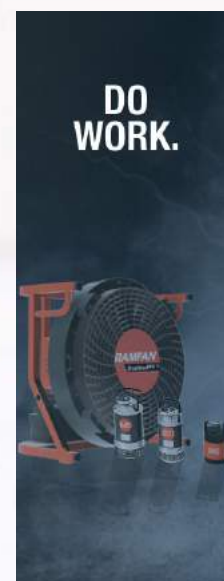

PLUG-IN ELECTRIC
BLOWERS





EV400/EV420

EV SERIES

Powerful Single-Speed electric PPV fan with a powder coated steel frame, all-terrain semi-pneumatic tires and full width retractable handle.

	EV400 (16"/40 cm)	EV420 (16"/40 cm)
ORDER #	EB80500	EB805010, EB81505 (CE)
MOTOR	1.5 hp (1.1 kW)	
POWER	115V, 1Ø, 15A or 20A, 60Hz	EB80510:230VAC, 1Ø, 10A, 60Hz EB81505:230VAC, 1Ø, 10A, 50Hz
PPV AIRFLOW	11,391 cfm (21,940 m ³ /hr)	10,994 cfm (30,039 m ³ /hr)
WEIGHT	68 lbs (31 kg)	
AMPS	15A / 20A	

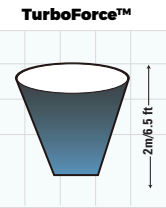

EX SERIES

The latest variable speed electric PPV fans with PowerStream® air straighteners for greater flow velocities and more flexible setback. Dual Current available on EX400 & EX500 models, with the flip of a switch, power fan from GFCI 20A fire truck circuit to GFCI 15A house circuit. EX500 and EX520 have optional ingratiated misting system.

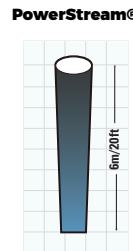

	EX400 (16"/40 cm)	EX420 (16"/40 cm)	EX500 (18"/46 cm)	EX520 (18"/46 cm)
ORDER #	EB80600	EB88245	EK86500	EK86520
MOTOR	1.5 hp (1.1 kW)			
POWER	115V, 1Ø, 15A or 20A, 60Hz	230VAC, 1Ø, 10A, 50/60Hz	115V, 1Ø, 15A or 20A, 60Hz	230VAC, 1Ø, 10A, 50/60Hz
PPV AIRFLOW	11,391 cfm (19,365 m ³ /hr)	10,994 cfm (18,690 m ³ /hr)	11,540 cfm (19,618 m ³ /hr)	13,354 cfm (22,702 m ³ /hr)
WEIGHT	68 lbs (31 kg)		70 lbs (32 kg)	
AMPS	15A / 20A			10A
NOISE	88 db @ 3' (1 m)		95 db @ 3' (1 m) / 91 db @ 10' (3 m)	



EX400/EX420



EX500/EX520



XP SERIES

ATEX certified motor to safely purge hazardous gases. Equipped with PowerStream® air straighteners for greater setback distances.

	XP400 (16"/40 cm)	XP420 (16"/40 cm)	XP500 (18"/46 cm)	XP520 (18"/46 cm)
ORDER #	EB80500X	EB80500X-230	EB90600X	EB90600X-230
MOTOR	1.5 hp (1.1 kW)			
POWER	115V, 1Ø, 15A, 50/60Hz	230VAC, 1Ø, 8A, 50/60Hz	115V, 1Ø, 15A, 50/60Hz	
PPV AIRFLOW	11,391 cfm (19,365 m ³ /hr)	11,391 cfm (18,690 m ³ /hr)	11,540 cfm (19,618 m ³ /hr)	13,354 cfm (22,702 m ³ /hr)
WEIGHT	68 lbs (31 kg)		72 lbs (33 kg)	
AMPS	80A / 15A			
NOISE	97 db @ 3' (1 m) / 95 db @ 10' (3 m)			



XP400/XP420



XP500/XP520

ACCESSORIES



Standard Duct with Storage Bags
Order# FDT-1615BR
16"/40 cm x 15'/4.6 m

Order# FDT-1625BR
16"/40 cm x 25'/7.6 m
For use with all 40 cm Fans

Order# FDT-185MSR
18"/46 cm x 16.4'/5 m
For use with all 46 cm Fans

Order# BG16
Storage Bag Only
Storage Bag for 16" (40 cm)



Integrated Misting System
Order# GH8112
1.85 gal/min @ 100 psi (1 l/min @ 6.9 bar)
(Compatible with EX500/EX520)

Order# EB8111
(Compatible with EV400/EV420, EX400/EX420)

Order# EL6013



Cooling Collars/Misters 40 cm Blowers
Order# ED-MIST16
For use with all 16" (40 cm) fans



HI-Expansion Foam Adapter
Order# HI-5000
(Compatible with all 18" RAMFAN models)

GAS

PPV BLOWERS





GX200L



GX200

ULTRA LIGHTWEIGHT SERIES

RAMFAN offers the lightest PPV fans on the market, providing the ultimate portability. Starting at only 36 lbs, the GX200L can easily be carried with one hand. Light enough to carry up stairwells and deploy in large commercial buildings or powerful enough for PPV in residential houses. Equipped with PowerStream® air straighteners.

	GX200L (16"/40 cm)	GX200 (16"/40 cm)
ORDER #	GG5500	GG5010
MOTOR	Honda GXH50 2.1 hp (1.6 kW)	
RUN TIME	1 hr 40 min	
PPV AIRFLOW	12,820 cfm (21,794 m ³ /hr)	
WEIGHT	36 lbs (16 kg)	48 lbs (22 kg)
AMPS	91 dB @ 3' (1 m) / 86 dB @ 10' (3 m)	

GF SERIES

Tried and True the GF series have been around since RAMFAN got its start. The economical gas fans are well known for their durability.

	GF165 (16"/40 cm)	GF210 (16"/40 cm)
ORDER #	GA5006	GE5001
MOTOR	Honda GX160 4.8 hp (3.5 kW)	
RUN TIME	1 hr 26 min	
PPV AIRFLOW Single Door Double Door	12,906 cfm (21,940 m ³ /hr)	17,670 cfm (30,039 m ³ /hr)
WEIGHT	84 lbs (38 kg)	88 lbs (40 kg)
NOISE	96.2 dB @ 3' (1 m)	96 dB @ 3' (1 m)



GF165



GF210



GX SERIES

High performance PPV fans for structural firefighting. The GX Series blowers are equipped with PowerStream® air straighteners that tighten the airflow to keep it focused over longer distances without losing significant power; permitting unrestricted setback from the access point, reduced interference with communication and flexible positioning. Optional integrated misters.

	GX310 (18"/46 cm)	GX350 (18"/46 cm)	GX400 (21"/54 cm)
ORDER #	GH5010	GH5020	GE5022
MOTOR	Honda GX160 4.8 hp (3.5 kW)	Honda GX200 5.5 hp (4.1 kW)	
RUN TIME	2 hr 6 min	1 hr 50 min	
PPV AIRFLOW Single Door Double Door	16,968 cfm (28,846 m ³ /hr)	18,705 cfm (31,799 m ³ /hr)	16,979 cfm (28,555 m ³ /hr) 22,500 cfm (38,250 m ³ /hr)
WEIGHT	82 lbs (37 kg)	84 lbs (38 kg)	88 lbs (40 kg)
NOISE	100 dB @ 3' (1 m)/ 95 dB @ 10' (3 m)	101 dB @ 3' (1 m)/ 97 dB @ 10' (3 m)	99 dB @ 3' (1 m)/ 95 dB @ 10' (3 m)



GX310/GX350



GX400

ACCESSORIES



BIGbore™ Exhaust Diverter (Muffler Fitting)
Order# GF7110-CZ (For Honda GC160 Motor)
Order# GF7110-KZ (For Honda GXH50 Motor)
Order# GF7110-LZ (For Honda GX270 Motor)
Order# GF7120-BZ (For Honda GX160 Motor)
Order# GF7120-GZ (For Honda GX200 Motor)
Order# GF7120-DZ (For Honda GX120 Motor)



Hour Meter
Order# GX1515
For use with Honda Motors
Keep track regularly
schedule maintenance



Exhaust Diverter Hose
Order# GF7115
For use with BIGbore™ Exhaust Diverter
2" x 12' (5 cm x 3.6 m)



Integrated Misting System
Order# GH8112 (For GX310, 350)
1.85 gal/min @ 100 psi (7 l/min @ 6.9 bar)
Order# GE8111 (GX400)



Cooling Collars/Misters 40 cm Blowers
Order# ED-MIST16
For use with all 16" (40 cm) Fans

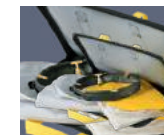

40 cm Multi-Purpose Accessory Kit
Order# BG16LFA
For use with all 16" (40 cm) Fans



Standard Duct with Storage Bags
Order# FDT-1615BR 16"/40 cm x 15'/4.6 m
Order# FDT-1625BR For use with all 40 cm Fans 16"/40 cm x 25'/7.6 m
Order# FDT-185MSR For use with all 18" (46 cm) Fans 18"/46 cm x 16.4'/5 m
Order# BG16 Storage Bag Only Storage Bag for 16" (40 cm)

WATER
PPV BLOWERS



SAFER...

RAMFAN's water powered design eliminates the threat of electrical shock and minimizes dangerous gas environments.

MORE EFFICIENT...

RAMFAN's patented Axial Flow Turbine Technology leads the way in converting water power into high velocity airflow more efficiently than any water fan on the market today.

BETTER....

RAMFAN's axial turbine is built of corrosion proof composite materials for long life, simple maintenance and easy replacement of parts.



WF390L

WF390L (16"/40 cm)	
ORDER #	WB5001LB, WB5001LNH, WB5001DIN (CCCF)
PPV AIRFLOW Single Door	10,886 cfm (18,506 m³/hr)
PRESSURE NOMINAL: MAX:	150 psi / 1.0MPa 250 psi / 1.7MPa
WEIGHT	60 lbs (27 kg)

WX500 (24"/61 cm)	
ORDER #	WX5001
PPV AIRFLOW Single Door	16,155 cfm @ 150 psi (27,464 m³/hr @ 1.0 MPa)
PRESSURE NOMINAL: MAX:	100 psi / 0.7 MPa 150 psi / 1.0 MPa
WEIGHT	60 lbs (27.22 kg)



WX500



WF540

WF540 (21"/54 cm)	
ORDER #	WD5010
PPV AIRFLOW Single Door	22,443 cfm @ 150 psi (38,154 m³/hr @ 1.0 MPa)
PRESSURE NOMINAL: MAX:	100 psi / 0.7 MPa 250 psi / 1.7 MPa
WEIGHT	75 lbs (34 kg)

ACCESSORIES



Integrated Misting System

Order# WD8111
(WF540) 1.85 gal/min @ 100 psi (7 l/min @ 7 bar)

Order# WB8111
(WF390L)

Many water connection fittings available. Call for details.

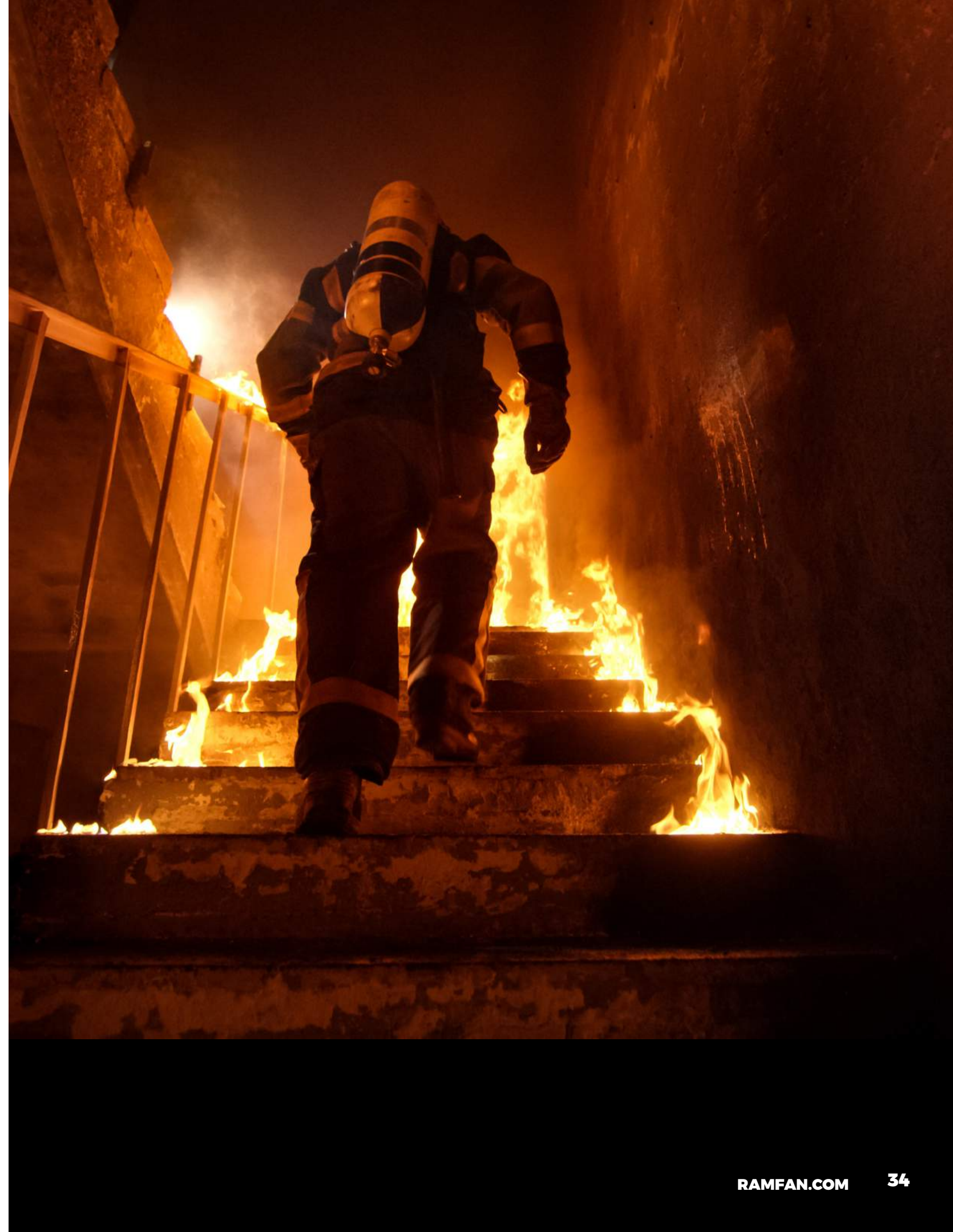

LSV

LARGE STRUCTURE

VENTILATORS



COME OF AGE AS ONLINE COMMERCE GROWS

Online retailing today is filling warehouses everywhere with products. Adding these to the current inventory of big box stores, airports, high-rises and hotels, the need for tools to fight large structure fires is clear.

These large structures require massive PPV ventilation because you can't support the fire fighting operations in a large structure with small structure equipment.

ONE HUGE FAN DOESN'T MAKE SENSE ANYMORE

Until now, Large Structure Ventilators have been huge monsters that are difficult to move and maneuver which can limit access to the structure on fire. They require a large storage space and have price tags that are budget-busters. This limits most cities to a single unit for the entire area.

RAMFAN LSV's are the solution to these problems. The largest LSV is a 28" trailer mounted fan that is small enough for one person to maneuver but powerful enough to quickly pressurize a high-rise stairwell and is offered at a price point so low you can buy 6 LSV's for every one truck mounted fan.

WHEN IT COMES TO EQUIPMENT ACCESS WHICH WOULD YOU PREFER: A SINGLE HUB OR A DISTRIBUTED NETWORK

If your city owns one large truck mounted fan stored in a central location and you respond to a warehouse fire on the outskirts of the city the response time may be too long to get the equipment to the scene. But if you had a distributed network of large fans it would cut the response time in less than half.

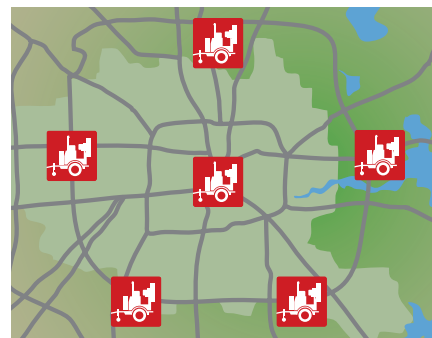
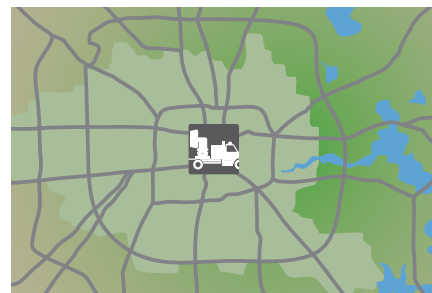

LSV = LARGE STRUCTURE VENTILATORS = BIG FANS FOR BIG BUILDINGS

Large volumes of high-velocity airflow is required for ventilating large and complex structures. Quickly removing smoke, gases, engine exhaust or particulates from a large confined area increases safety of both personnel and property, reducing the chances of toxic inhalation and general atmospheric danger.



GX500



GX600

GX SERIES

High performance PPV fans for structural firefighting. The GX Series blowers are equipped with PowerStream® air straighteners that tighten the airflow to keep it focused over longer distances without losing significant power; permitting unrestricted setback from the access point, reduced interference with communication and flexible positioning. Optional integrated misters.

	GX500 (24"/60 cm)	GX600 (28"/70 cm)
ORDER #	GD5005, GD5003 (CCCF Certified)	GJ5005
MOTOR	Honda GX270 8.5 hp (6.3 kW)	Vanguard 18 hp (13.4 kW) V-Twin OHV mod .3
RUN TIME	2 hrs 2 min	2 hrs 40 min
PPV AIRFLOW		
Single Door	27,800 cfm (47,260 m³/hr)	32,500 cfm (55,250 m³/hr)
Double Door	37,700 cfm (64,090 m³/hr)	49,000 cfm (83,300 m³/hr)
WEIGHT	137 lbs (62 kg)	175 lbs (80 kg)
NOISE	100 dB @ 3' (1 m) / 95 dB @ 10' (3 m)	105 dB @ 3' (1 m) / 103 dB @ 10' (3 m)

	VX700 (Skid Mounted) (28"/70 cm)	VX700 (US Trailer Mounted) (28"/70 cm)	VX700 (European Trailer Mounted) (28"/70 cm)	VX700 (China Trailer Mounted) (28"/70 cm)
ORDER #	GK500	GK5005	GK5010	GK5050
MOTOR	Honda GX630 23 hp (17 kW)			
RUN TIME	2 hrs 30 min			
PPV AIRFLOW				
Double Door	46,700 (79,390 m³/hr)			
Warehouse	60,200 cfm (105,400 m³/hr)			
WEIGHT	220 lbs (100 kg)	920 lbs (417 kg)		
NOISE	100 dB @ 3' (1 m) / 95 dB @ 10' (3 m)			



VX700

VARIATIONS



European Trailer Mounted



Skid Mounted



Continuous Track Mounted

ACCESSORIES

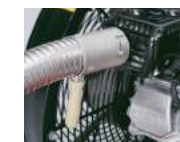

BIGbore™ Exhaust Diverter (Muffler Fitting)
Order# GF7110-LZ
(GX500 and VX700)



Hour Meter
Order# GX1515 (For use with Honda Motors)
Keep track regularly schedule maintenance



Exhaust Diverter Hose
Order# GF7115
2" x 12' (5 cm x 3.6 m)



Integrated Misting System
Order# GD8111 (GX500)
Order# GD8111M (GX500 Option BSP)
Order# GJ8111 (GX600 only)

ELECTRIC

CONFINED SPACE FANS



CONFINED SPACE VENTILATORS

Confined space rescues require additional considerations to perform a rescue. In addition to general risks there is a danger of asphyxiation (lack of oxygen), poisoning, or fire and explosion. A fan can be used during confined space rescue to combat the additional risks. Ventilation can be performed by supplying or exhausting air or both. The weight and characteristics of the atmospheric hazard as well as the environmental conditions of the general area will dictate the type(s) of ventilation applied. Using a blower that can be used in positive or negative pressure ventilation is ideal. The safest option is to use the UB20xx explosion proof ventilator. It prevents a source of ignition in a flammable environment. In addition to the fan, consider an assortment of duct and Manhole Entry Device (M.E.D.). The M.E.D. will permit access through the manhole without interrupting airflow. Spaces that are deep may require extensive duct work. Multiple fans used in different configurations may be required. The more options you have, the better equipped you will be to address the problem.



	UB20 (115V)	UB20 (230V)	UB20 (12VDC)
ORDER #	ED7003	ED8002	ED9002
MOTOR	1 hp (0.25 kW)		0.25 hp (0.19 kW)
POWER	115V, 1Ø, 50/60 Hz	230V, 1Ø, 50/60 Hz	12 VDC
FREE AIR THROUGH DUCT	980 cfm (1,666 m³/hr)	819 cfm (1,392 m³/hr)	862 cfm (1,465 m³/hr)
15'/4.6 m w/one 90° turn:	789 cfm (1,341 m³/hr)	659 cfm (1,120 m³/hr)	695 cfm (1,181 m³/hr)
15'/4.6 m w/two 90° turns:	666 cfm (1,132 m³/hr)	558 cfm (948 m³/hr)	586 cfm (996 m³/hr)
25'/7.6 m w/one 90° turn:	722 cfm (1,227 m³/hr)	603 cfm (1,025 m³/hr)	
25'/7.6 m w/two 90° turns:	614 cfm (1,044 m³/hr)	510 cfm (867 m³/hr)	
WEIGHT	17 lbs (8 kg)		
AMPS	9.5A / 2.5A	4.8A / 1.3A	11.5A
NOISE	74 dB		

HIGH VOLUME CONFINED SPACE VENTILATORS

Proper ventilation in confined spaces is essential for a safe work environment. Atmospheric hazards cause approximately 90% of worker injuries and fatalities in confined spaces. Ventilation of a confined space should be done to stabilize the environment. This could be to replace the bad air, make the air breathable, get rid of toxic vapors, make the area warmer or cooler, remove dust and so on. The larger the confined space the more powerful ventilator you will need. The RAMFAN UB30 is a high power ventilation unit moving up to 4,114 m³/hr of air for use in confined spaces. Constructed from ultra durable polymer to stand up to rugged work environments. The fan will provide reliable exhaustion or ventilation on the job site.



	UB30 (115V)	UB30 (230V)
ORDER #	EJ4002	EJ8002
MOTOR	1 hp (0.75 kW)	
POWER	115V, 1Ø, 50/60 Hz	230V, 1Ø, 50/60 Hz
FREE AIR THROUGH DUCT	2,420 cfm (4,114 m³/hr)	2,017 cfm (3,429 m³/hr)
15'/4.6 m w/one 90° turn:	2,050 cfm (3,485 m³/hr)	1,650 cfm (2,805 m³/hr)
15'/4.6 m w/two 90° turns:	2,050 cfm (3,485 m³/hr)	1,500 cfm (2,550 m³/hr)
25'/7.6 m w/one 90° turn:	1,875 cfm (3,188 m³/hr)	1,376 cfm (2,340 m³/hr)
25'/7.6 m w/two 90° turns:	1,825 cfm (3,103 m³/hr)	1,400 cfm (2,380 m³/hr)
	1,750 cfm (2,974 m³/hr)	1,324 cfm (2,250 m³/hr)
WEIGHT	37 lbs (17 kg)	
AMPS	33A / 8A	17A / 5A
NOISE	95 dB 3' (1 m)	

	UB20xx (115V)	UB20xx (230V)
ORDER #	EF7002	EF8002
MOTOR	0.33 hp (0.25 kW)	
POWER	115V, 1Ø, 50/60 Hz	230V, 1Ø, 50/60 Hz
FREE AIR THROUGH DUCT	980 cfm (1,666 m³/hr)	819 cfm (1,392 m³/hr)
15'/4.6 m w/one 90° turn:	789 cfm (1,341 m³/hr)	659 cfm (1,120 m³/hr)
15'/4.6 m w/two 90° turns:	666 cfm (1,132 m³/hr)	558 cfm (948 m³/hr)
25'/7.6 m w/one 90° turn:	722 cfm (1,227 m³/hr)	603 cfm (1,025 m³/hr)
25'/7.6 m w/two 90° turns:	614 cfm (1,044 m³/hr)	510 cfm (867 m³/hr)
WEIGHT	27 lbs (12 kg)	
AMPS	7A / 2A	
NOISE	74 dB	



	EFi75xx (115V)	EFi75xx (230V)
ORDER #	EB7201XX	EB7201XX-230
MOTOR	0.75 hp (0.56 kW)	
POWER	115V, 1Ø, 50/60 Hz	230V, 1Ø, 50/60 Hz
FREE AIR THROUGH DUCT	2,500 cfm (4,250 m³/hr)	
4.6 m w/one 90° turn:	1,664 cfm (2,829 m³/hr)	
4.6 m w/two 90° turns:	1,529 cfm (2,599 m³/hr)	
WEIGHT	44 lbs (20 kg)	
AMPS	37A / 8.8A	27A / 4.4A
NOISE	89 dB	



ACCESSORIES



Standard Duct
Order# FDT-21624026BR
8'/20 cm x 15'/4.6 m

Order# FDT-21624076BR
8'/20 cm x 25'/7.6 m



Quick-Couple™ Canister
Order# ED7004CS
Quick-Couple Canister with 15'(4.6 m) Standard Duct

Order# ED7004CL
Quick-Couple Canister with 25'(7.6 m) Standard Duct

Order# ED7004CL/DS - Quick-Couple™ Canister w/ (2pcs) 5'/1.5 m and 15'4.6 m duct



Anti-static Duct
Order# FDT-0815CBB
8'/20 cm x 15'/4.6 m

Order# FDT-0825CBB
8'/20 cm x 25'/7.6 m



Quick-Couple™ Canister
Order# ED7004CS
Quick-Couple Canister with 15'(4.6 m) Standard Duct

Order# ED7004CL
Quick-Couple Canister with 25'(7.6 m) Standard Duct

Order# ED7004CL/DS - Quick-Couple™ Canister w/ (2pcs) 5'/1.5 m and 15'/4.6 m duct



Standard Duct
Order# FDT-30534005BB
12'/30 cm x 16'/5 m

Order# FDT-30534010BB
12'/30 cm x 32'/10 m



Anti-static Duct
Order# FDT-1215CBB
12'/30 cm x 15'/4.6 m

Order# FDT-1225CBB
12'/30 cm x 25'/7.6 m



EFi50xx/EFi120xx/EFi150xx

SAFEST



EURAMCO'S SPECIALTY. CERTIFIED EXPLOSION-PROOF PORTABLE VENTILATORS.			
	EFi50XX* (16"/40 cm)	EFi120XX (16"/40 cm)	EFi150XX (16"/40 cm)
ORDER NO#	EA8000XX, EA8000XX-230	EA8120XX, EA8120XX-110	EG8200XX, EG8200XX-230
MOTOR	0.5 hp (0.37 kW)	1.2 hp (0.9 kW)	1.5 hp (1.1 kW)
ELECTRIC	115/230V, 1Ø, 50/60 Hz	110/240V, 1Ø, 50Hz	115/230V, 1Ø, 50/60 Hz
FREE AIR THROUGH DUCT	3,200 cfm (5,440 m³/hr)	3,750 cfm (6,375 m³/hr)	4,459 cfm (7,580 m³/hr)
4.6 M W/ONE 90° TURN:	1,935 cfm (3,289 m³/hr)	2,700 cfm (4,590 m³/hr)	3,179 cfm (5,404 m³/hr)
WEIGHT	49 lbs (22 kg)	55 lbs (25 kg)	61 lbs (28 kg)
AMPS	25A /6A, 13A / 3A	54A / 10A, 27A / 5A	80A / 15A, 40A / 8A
NOISE	90.2 db @ 3' (1 m)	86.1 db @ 3' (1 m)	90.2 db @ 3' (1 m)

*Certified Motor Only

EFC50x/EFC120x/EFC150x

SAFER

HEAT-RESISTANT LEXAN® HOUSING, AND USE AN EXPLOSION-PROOF MOTOR			
	EFC50X (16"/40 cm)	EFC120X (16"/40 cm)	EFC150X (16"/40 cm)
ORDER NO#	EA7000X	EA7300X	EG8000X,EG8000X-230
MOTOR	0.5 hp (0.37 kW)	1.2 hp (0.9 kW)	1.5 hp (1.1 kW)
ELECTRIC	115/230V, 1Ø, 50/60 Hz	230V, 1Ø, 50Hz	115/230V, 1Ø, 50/60 Hz
FREE AIR THROUGH DUCT	3,200 cfm (5,440 m³/hr)	3,750 cfm (6,375 m³/hr)	4,459 cfm (7,580 m³/hr)
4.6 M W/ONE 90° TURN:	1,935 cfm (3,289 m³/hr)	2,700 cfm (4,590 m³/hr)	3,179 cfm (5,404 m³/hr)
WEIGHT	49 lbs (22 kg)	55 lbs (25 kg)	61 lbs (28 kg)
AMPS	25A /6A, 10A / 3A	27A / 5A	80A / 15A, 40A / 8A
NOISE	90.2 db @ 3' (1 m)	86.1 db @ 3' (1 m)	90.2 db @ 3' (1 m)



EFC50/EFC120/EFC150

SAFE



HEAT-RESISTANT LEXAN® HOUSING			
	EFC50 (16"/40 CM)	EFC120 (16"/40 CM)	EFC150 (16"/40 CM)
ORDER NO#	EA7000, EA7000-230	EA7300	EG8000,EG8000-230
MOTOR	0.5 hp (0.37 kW)	1.2 hp (0.9 kW)	1.5 hp (1.1 kW)
ELECTRIC	115/230V, 1Ø, 50/60 Hz	230V, 1Ø, 50Hz	115/230V, 1Ø, 50/60 Hz
FREE AIR THROUGH DUCT	3,200 cfm (5,440 m³/hr)	3,750 cfm (6,375 m³/hr)	4,459 cfm (7,580 m³/hr)
4.6 M W/ONE 90° TURN:	1,935 cfm (3,289 m³/hr)	2,700 cfm (4,590 m³/hr)	3,179 cfm (5,404 m³/hr)
WEIGHT	49 lbs (22 kg)	55 lbs (25 kg)	61 lbs (28 kg)
AMPS	25A /6A, 10A / 3A	27A / 5A	80A / 15A, 40A / 8A
NOISE	90.2 db @ 3' (1 m)	86.1 db @ 3' (1 m)	90.2 db @ 3' (1 m)

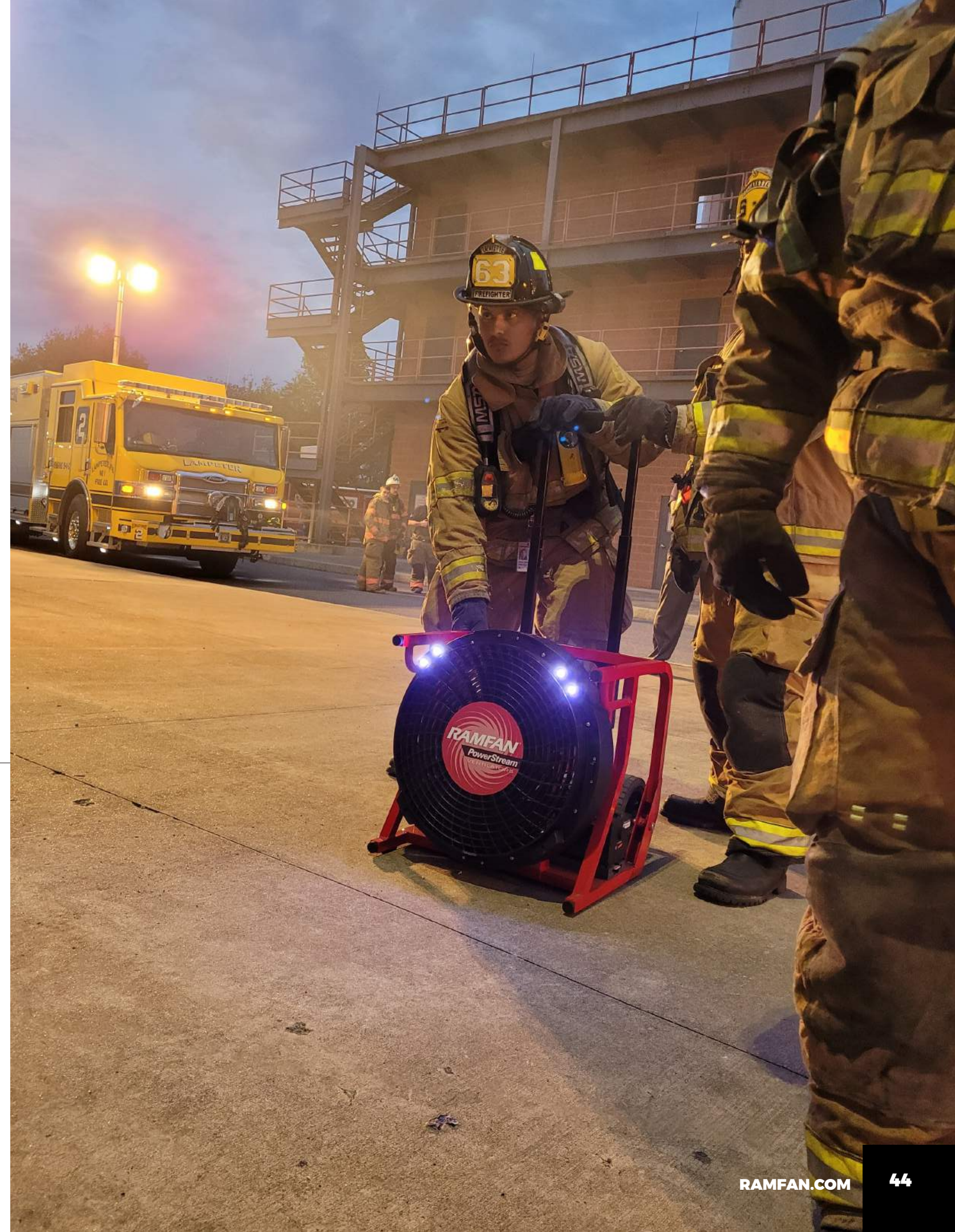

EURAMCO GROUP'S CERTIFIED PRODUCT MARK OF EXCELLENCE

Euramco Group's Certified Product Mark is our visual statement to you that RAMFAN Portable Ventilation Fans are Quality Manufactured and have been tested by Recognized Third Party Testing Facilities throughout the world to certify all product performance information quoted in our catalog, sales materials and on our website is accurate. In addition, the Certified Product Mark assures you that all required operating certifications and designations required by the applicable agencies are in order and available for your review.

EURAMCO GROUP IS AN ISO 9001:2015 COMPANY: ISO 9000 is the internationally recognized Quality Management Standard used in more than 760,000 companies in 154 countries to maintain an internationally accepted standardized quality management throughout the world. Our commitment to this standard means our products are built in accordance with documented procedures and control processes to ensure ongoing uniformity and reliability.



THE AIR MOVEMENT AND CONTROL ASSOCIATION | The Air Movement and Control Association is the worldwide recognized authority for the development of standards and measurement of air movement. Euramco Group is a member of AMCA and uses their PPV test. ANSI/AMCA Standard 240 - Laboratory Methods of Testing Positive Pressure Ventilators for Aerodynamic Performance Rating establishes a uniform method of laboratory testing of positive pressure ventilators (PPVs) in order to determine the airflow rate.



ATEX HAZARDOUS CONDITIONS DIRECTIVE 2014/34/EU | This directive applies to all electrical equipment for use in potentially explosive atmospheres; defined as gas, vapor or mist and are capable of causing an explosion through their own potential sources of ignition. RAMFAN Hazardous Location Fans are Whole Unit ATEX Certified for use in dangerous work environments as defined above anywhere in the world.



IECEX | The objective of the IECEx System is to facilitate international trade for equipment and services for use in explosive atmospheres, while maintaining the required level of safety. The IECEx has put in place a number of Conformity Assessment Schemes which provide assurance that equipment and systems are manufactured and operated according to the highest International Standards of safety.



UNDERWRITERS LABORATORIES, INC. | UL is an independent, third party product safety certification organization that evaluates products for compliance to specific standards and permits those products that comply to carry the UL Mark. The UL Mark is recognized worldwide as a symbol of product safety.



INMETRO - NATIONAL INSTITUTE OF METROLOGY, NORMALIZATION AND INDUSTRIAL QUALITY IN BRAZIL | Products obtain the INMETRO Certification Mark when they meet National Standards or specific technical requirements as detailed in the Brazilian Conformity Evaluation System (SBAC).



UNIFORM CONFORMITY PROCEDURES SET FORTH BY THE EUROPEAN UNION | The CE Mark is a mandatory marking for certain product groups and certifies that a product meets EU consumer safety, health or environmental requirements. In order to use the CE mark on a product the manufacturer must draw up a Declaration of Conformity in which they attest conformity with all relevant EU Directives.



CHINA COMPULSORY CERTIFICATION OF FIRE PRODUCTS | China Compulsory Certification of fire protection products, also known as "3C certification", it is the Chinese government to protect consumer safety and national security, strengthen product quality management to implement a product conformity assessment system.

PLEASE NOTE: YOU CAN FIND VERIFICATION MARKINGS FROM THE BELOW ORGANIZATIONS THROUGHOUT THE CATALOG.

CERTIFICATIONS & STANDARDS

CERTIFICATIONS

	ATEX- European Union Hazardous Location Certification by UL International Demko A/S notified by number 0539
	European Union EMC and Safety
	Recognized Component Mark for Canada and the United States
	International Electric Code - worldwide certification standards for electrical equipment used in hazardous locations.
	INMETRO Mark - Brazilian Hazardous Location Conformity
	North American Hazardous Location Conformity
	Registered by UL to a specified ISO or QS System.

RATINGS

IP RATING	FIRST DIGIT	SECOND DIGIT
IP55	Limited protection against dust ingress. (no harmful deposit)	Protected against low pressure water jets from any direction. Limited ingress permitted,
IP65	Totally protected against dust ingress.	Protected against low pressure water jets from any direction. Limited ingress permitted,

STANDARDS

ORGANIZATION		
	ANSI American	The American National Standards Institute (ANSI) empowers its members and constituents to strengthen the U.S. marketplace position in the global economy.
	NSN NO.	13-digit numeric code, identifying all the 'standardize material items of supply' as the have been recognized by all NATO countries including United States Department of Defense.
	IMPA CODES	Is used in the marine industry, this aims to bridge the language barrier and offer worldwide shipping companies an easy way to order goods.



SERVICES

TECHNICAL ASSISTANCE

Our Customer Service Support and Engineers are available to assist you with any set-up, operation or application inquiries during our hours of operation. Operation manuals are also included in product packages. For assistance please contact Customer Service or email theteam@euramco.com

PLACING YOUR ORDER

Contact our Customer Service Department if you need help with placing your order.

For prompt, accurate ordering please be able to provide the following:

- A Purchase Order or letter with the company name or logo, address & approval signature. Purchase Orders must include a P.O. #, Bill To Address, ship To Address, Model #, Order #, quantity of each products ordered and shipping method.

Purchase Orders can be received by
Fax: +1 (619) 670-7345 or
Email: theteam@ramfan.com

- A confirmation will follow all orders placed.

AMERICA

Hours of Operation
M-F 8:30 a.m. - 5:00 p.m. PST

Toll Free +1(800) 472-6326
Phone +1(619) 670-9590
Fax +1(619) 670-7345

CHINA

Hours of Operation
M-F 8:30 a.m. - 5:00 p.m.

Phone +86-574-87979390
Fax +86-574-87979391

EUROPE - LUXEMBOURG

Hours of Operation
M-F 9:00 a.m. - 5:00 p.m.

Phone +352-26008055
Fax +352-26008056

SINGAPORE

Hours of Operation
M-F 8:30 a.m. - 5:00 p.m.

Phone +65-9773 33 35

Find us on



@euramcogroup

[linkedin.com/company/euramcogroup](https://www.linkedin.com/company/euramcogroup)

Euramco Group

Contents of this catalog are subject to change without notice.
Image Disclaimer: We operate a policy of continuous product development. Images are used for illustration purposes only and may not be the latest version of the product.



**Headquarters -
USA**

2746 Via Orange Way
Spring Valley, CA
91978 USA

Europe

68, Avenue de la
liberte
1931 Luxembourg

China 中国

优兰特集团
No.239,Guian South
road, ZhenHai District,
NingBo, China. 315201

Singapore

1 Fullerton Road
#02-01 One Fullerton
Singapore 049213

General Inquiries: theteam@ramfan.com
Support: support@ramfan.com