

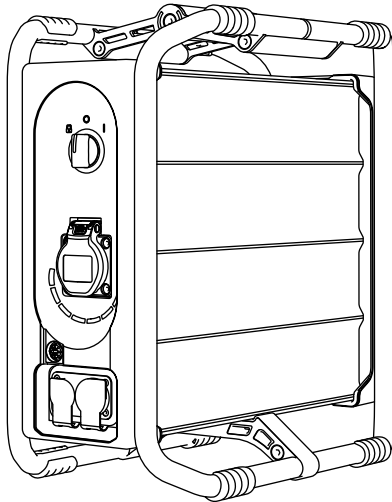







 **instagrid** ONE
max



USER MANUAL V2.0

A - SYMBOLS



Note	Important information that must be heeded.
Caution	Potentially dangerous situation. If this is not prevented, it could potentially lead to minor injuries.
Warning	Potentially dangerous situation which, if not prevented, will result in serious injuries or fatality.
Danger	Imminent danger resulting in serious injuries or fatality.
	General danger warning
	Electric shock warning
	Read the user manual and safety notes.
	Check / look closely.
	Protection class II
	Do not dispose with domestic waste.
	CE marking: Confirms the power tool conforms with the directives of the European Community.

B - SAFETY NOTES



B.1 - Intended use

- The instagrid ONE max is used for the mobile power supply of electrical devices which are intended for operation via a standard domestic power socket (230 V / 16 A); hereinafter referred to as "loads".
 - Exceptions to this are all devices that feed power into the supply grid; e.g. "plug-in solar panels".
 - Also exempt are devices that rely on a protective conductor connection to perform safety functions.
- Due to the special design of the instagrid ONE max, both the operation of sensitive loads (e.g. AV equipment) and the use of devices with strong feedback effects on the AC supply (e.g. caused by high starting currents or reactive power requirements) pose no problems.
- The instagrid ONE max complies with strict limit values both in terms of the emission of electromagnetic interference and in terms of insensitivity to such interference, meaning it is equally suitable for use in domestic and industrial environments.
- The instagrid ONE max meets the requirements of protection rating IP54, and is therefore suitable for use indoors and outdoors.

B.2 - Using the safety notes

-   Read all the safety notes and instructions. Failure to observe safety notes and instructions may cause electric shock, fire or severe injuries. Store all safety notes and instructions within easy reach and close to the equipment.

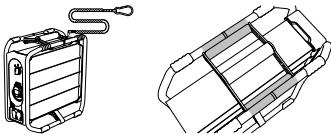
B.3 – Rules for handling the instagrid ONE max safely

- Under no circumstances may the instagrid ONE max be opened. In particular, the “end caps” [2 | 6] must not be opened. Maintenance and repair may only be performed by a trained specialist.
- Control elements and plug and socket devices of the instagrid ONE max must not be modified. Replacement may only be performed by a trained specialist.
- The outlets [4 | 9] of the instagrid ONE max must not be short-circuited.
- The electrical contacts [4 | 8 | 9] of the instagrid ONE max must not be touched with fingers, tools or other objects.
- The instagrid ONE max must not be used as a base for working on or as a makeshift workbench.
- The housing [10] of the instagrid ONE max must not be submerged in water or mud.
- The instagrid ONE max must only be used within the operating limits specified in [\[section 2.2\]](#).
- In the event of battery fire, the fire must be extinguished with water. If possible, the instagrid ONE max must be completely covered in water. The fire brigade must be called and notified that lithium-ion batteries are burning.
- Vapours can escape if the instagrid ONE max is damaged or used improperly. The vapours can irritate the respiratory tract. In this case, fresh air must be supplied and, in the event of complaints, a doctor must be sought.
- If used incorrectly, fluid can escape from the batteries of the instagrid ONE max. In the event of skin contact, the fluid must be washed off with water.
- If the fluid comes into contact with the eyes, also seek medical attention. Leaking battery fluid may lead to skin irritation or burns.
- The instagrid ONE max must not be stored in temperatures above 65°C and must be kept away from external heat sources (e.g. long solar radiation, radiant heaters, fire). Contact with ambient air must not be restricted (e.g. through operation in a sealed container).
- The instagrid ONE max must neither be used nor stored in an area at risk of explosion.
- The instagrid ONE max must not be moved using cranes, lifting aids or other lifting equipment.
- In order to prevent injury from the instagrid ONE max falling over or falling down, the stable positioning of the instagrid ONE max must also be ensured when in operation with connected loads. To this end, easy access to the connected instagrid ONE max and adequate cable length must be ensured. Connected cables must not be placed under strain.
-  Damage caused by falling down must be prevented. Therefore, stable positioning on a non-slip floor must be provided, and protrusions over the edge of the floor must be avoided. The instagrid ONE max must be secured against falling.
- In all cases, the instagrid ONE max must be checked for damage after a fall. In the event of external damage, the instagrid ONE max must no longer be used. Exceptions to this are damage to the frame [7] or the carry handle [1]. In the case of all other damage, TRANSPORT mode (see [\[section 5.2.4\]](#)) must be activated by turning the rotary switch [3] to . The customer service department must be contacted immediately, see [\[section 10\]](#).
- Damage caused by the accidental falling of objects onto the instagrid ONE max or the shipping box must be prevented. In all cases, the instagrid ONE max must be checked for damaged parts following such impacts. In the event of external damage, the instagrid ONE max must no longer be used. Exceptions to this are damage to the frame [7] or the carry handle [1]. In the case of all other damage, TRANSPORT mode (see [\[section 5.2.4\]](#)) must be activated by turning the rotary switch [3] to . The customer service department must be contacted immediately, see [\[section 10\]](#).

- The instagrid ONE max and its accessories must be checked for damage prior to each instance of commissioning. When doing so, the correct functioning of the LED display [5] must be ensured, see [section 5.2]. In the event of damage, TRANSPORT mode (see [section 5.2.4]) must be activated by turning the rotary switch [3] to . A damaged or defective instagrid ONE max must not be operated. The customer service department must be contacted immediately, see [section 10].
- The connecting of loads to the outlets of the instagrid ONE max [4 | 9] which continuously feed power into the supply grid (e.g. plug-in solar panels) may lead to damage to the instagrid ONE max and loads.
- The instagrid ONE max corresponds to protection class II and must not be earthed in operation.
- Local regulations governing both the erection of low-voltage systems and the safe operation of electrical loads must be complied with at all times.
- All connected cables must be routed so that they cannot get crushed by objects and nobody can stand on them.
- The instagrid ONE max must only be connected to the mains using the enclosed charging cable. Alternatively, a cable of identical design can be used. If you have any questions in this regard, please refer either to an electrical specialist or contact instagrid; see [section 10].
- Do not operate the instagrid ONE max if the power cable exhibits a defect or the insulation is damaged. Protect the power cable so that it can neither become crushed, kinked nor damaged in any other way. In particular, pay attention to the power plug and the charging port [8] on the instagrid ONE max. A replacement cable can be sourced directly from instagrid; see [section 10].
- The instagrid ONE max can only be disconnected from the mains via the charging cable (see [section 1]), which must always be easily accessible for mains disconnection.
- The instagrid ONE max must not be used as a step or climbing aid.
- The protective caps of unused ports must be closed.
- The implementation of prescribed regular checks must be ensured and, in particular, no defective loads may be used with the instagrid ONE max.
- Prior to activating the instagrid ONE max, you must ensure that connected loads are switched off.
- Prior to connecting a load to the instagrid ONE max, you must ensure that it is switched off.
- Loads connected to the instagrid ONE max must always be switched off after operation.
- The instagrid ONE max must not be used to operate life-sustaining medical loads.
- The instagrid ONE max must not be cleaned with water jets. In particular, the use of pressure washers is not permitted.
- The instagrid ONE max must be prevented from coming in contact with chemicals, fuels and lubricants.
- Operation of the instagrid ONE max should always be monitored by an experienced user, especially if minors, inexperienced adults or people with disabilities / impairments are using the instagrid ONE max.

C - TABLE OF CONTENTS

A - SYMBOLS	2
B - SAFETY NOTES	2
B.1 - Intended use.....	2
B.2 - Using the safety notes.....	2
B.3 - Rules for handling the instagrid ONE max safely.....	3
C - TABLE OF CONTENTS	5
D - WARRANTY INFORMATION	6
1. SCOPE OF SUPPLY	6
2. DEVICE DESCRIPTION	7
2.1 Connections, control and display elements.....	7
2.2 Technical data.....	8
3. SAFETY CONSIDERATIONS WHEN OPERATING THE INSTAGRID ONE MAX	9
3.1 Passive protection at the outlet / IT network.....	9
3.2 Active protection at the outlet.....	9
3.3 Additional measures for increasing user safety.....	9
3.4 Passive protection at the inlet.....	10
4. INITIAL COMMISSIONING	10
5. OPERATING STATES AND OPERATION	11
5.1 Concept of operation.....	11
5.2 Operating states.....	12
5.2.1 OFF.....	12
5.2.2 CHARGE.....	12
5.2.3 DISCHARGE.....	13
5.2.4 TRANSPORT.....	13
5.3 Features.....	14
5.3.1 Starter battery.....	14
6. WARNINGS AND FAULTS	14
6.1 Warning.....	14
6.1.1 External problems.....	14
6.1.2 Temperature problems.....	15
6.2 Faults.....	15
7. SERVICE AND MAINTENANCE	15
7.1 Replacing the charging inlet fuse.....	15
7.2 Replacing the frame.....	15
8. MISCELLANEOUS	15
8.1 Storage.....	15
8.2 Transport and shipping.....	16
8.3 Cleaning and care.....	16
9. MANUFACTURER'S DECLARATION	17
9.1 Declaration of conformity.....	17
9.2 WEEE declaration / disposal.....	17
9.3 Licences and copyrights.....	17
10. CONTACT	17
10.1 General enquiries.....	17
10.2 In case of damage or repair.....	17
10.3 Address.....	17

D - WARRANTY INFORMATION

Instagrid (see [\[section 10\]](#)) guarantees that the product instagrid ONE max is free of material and manufacturing defects and undertakes to repair or replace any defective parts free of charge. The period of limitation for claims for defects is 24 months following delivery.

1. SCOPE OF SUPPLY

Thank you for purchasing the instagrid ONE max. Check the completeness of the delivery following receipt. The following parts must be included:

- instagrid ONE max



- Charging cable



- User manual



2. DEVICE DESCRIPTION

The instagrid ONE max is a portable, lithium-ion-cell energy storage system with 230 V AC inlet and outlets. The main storage unit with a rated energy content of 2,100 Wh is split into independent elements with an energy content of less than 100 Wh.

There is also a starter battery, which has a special role in starting the instagrid ONE max; see [\[section 5.3.1\]](#).

The cells in lithium-ion batteries are sealed so as to be gas-tight and harmless, as long as the manufacturer's instructions are followed during use and handling. The user is liable for any improper use; see [\[section B.1\]](#).

The instagrid ONE max offers the option of communication with a smartphone / tablet or a PC via an in-built Bluetooth interface. You can find more information on this at: <https://instagrid.co/manuals>

2.1 Connections, control and display elements

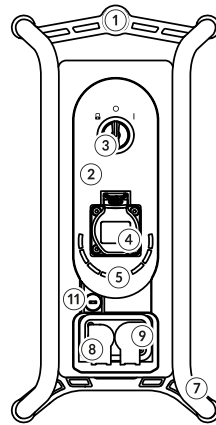
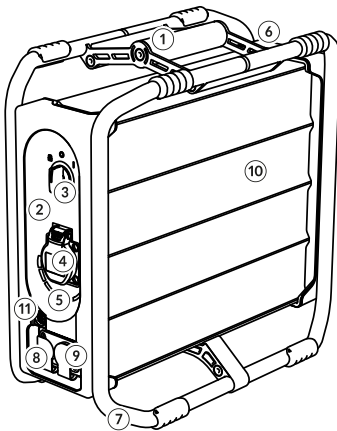

1. Carry handle
2. Front end cap
3. Rotary switch
4. CEE 7/X outlet socket
5. LED display
6. Rear end cap
7. Frame
8. AC charging inlet (*)
9. Outlet socket (*)
10. Housing
11. Input fuse

(*) powerCON® TRUE1® TOP

2.2 Technical data

Parameters	Value
Operating state: Discharge	
Output voltage	230 V AC / 50 Hz
Rated power	3,600 W / 16 A
150% overload (5,400 W / 24 A)	Operation for >500 s possible
200% overload (7,200 W / 32 A)	Operation for >50 s possible
250% overload (9,000 W / 40 A)	Operation for >10 s possible
Peak power	18,000 W / 80 A
Maximum short-circuit current	500 A (peak)
Maximum operating time (idle)	150 h
Line protection	16 A – similar to "B16" circuit breaker
Permitted operating temperature	-20°C to 60°C
Operating state: Charge	
Input voltage	120–240 V AC / 50–60 Hz
Rated power	500–1,000 W / 4 A
Power consumption when charging process fully complete	<0.5 W
Charging time	<3 h to 100%
Permitted operating temperature	0°C to 45°C
General information	
Capacity	2,074 Wh
Weight	20 kg
Dimensions	420 × 210 × 420 mm
Protection rating	IP54
Protection class	Class II / double-insulated
Noise emissions	<10 dB(A)
Storage	>3 years
Connections	
Outlet socket	CEE 7/3 socket (16 A)
Outlet socket	Neutrik powerCON® TRUE1® TOP
AC charging inlet	Neutrik powerCON® TRUE1® TOP
Input fuse	T5A L 250 V

3. SAFETY CONSIDERATIONS WHEN OPERATING THE INSTAGRID ONE MAX

3.1 Passive protection at the outlet / IT network

When connecting a load to the instagrid ONE max, a low-voltage network is established, during the operation of which statutory regulations must be observed. It is the user's responsibility to research and apply the locally applicable regulations – instagrid assumes no liability in this regard.



The design of the instagrid ONE max ensures galvanic separation (isolation) between the charging inlet [8] and housing [10], the outlet [4 | 9] and housing, as well as between the charging inlet and outlet. As a result, both the requirements placed on a protection class II device are met and the feature of protective separation between inlet and outlet is implemented. This means the outlet has no direct earth connection and is considered a special safety feature, because in the event of an (individual) insulation fault, no shock current can flow.

Such a network is referred to as an IT (isolé-terre) network. The operation of protection class I loads on the instagrid ONE max is absolutely possible. The equipotential bonding of the two outlets [4 | 9] is ensured through the design.

3.2 Active protection at the outlet

The outlet of the instagrid ONE max is protected from overload by several independently overlapping mechanisms:

- Energy content – due to the limited energy content of the integrated storage unit, continuous current drain is not possible. The rated current of 16 A can be drained for a maximum of 35 minutes; at 20 A for 27.5 minutes.
- Thermally induced shutdown – the internal temperature of the instagrid ONE max is monitored continuously during operation. Exceeding the fixed limit values leads to a shutdown of the instagrid ONE max; see [section 6.1.2]. The time after which the shutdown is triggered varies depending on ambient temperature and load current. At 25°C and 16 A, a complete discharge of the instagrid ONE max (100% -> 0%) is possible without triggering a shutdown.
- Internal resistance – the internal resistance of the instagrid ONE max limits the possible short-circuit current to values less than 500 A (peak).
- Electronic fuse – during operation, the instagrid ONE max continuously measures the outlet current actually flowing and calculates a temporal evaluation of the measured values. Exceeding the fixed limit values leads to a shutdown of the instagrid ONE max; see [section 6.1.1]. The current/time characteristic resulting from the electronic fuse alone is within the range that is typical for "B16"-type circuit breakers.

Furthermore, by means of a similarly redundantly active concept, special characteristics of the output voltage are continuously monitored; e.g.:

- Frequency
- RMS voltage
- Peak voltage
- DC offset

3.3 Additional measures for increasing user safety

As shown in [section 3.1] and [section 3.2], operation of a load on the instagrid ONE max is accompanied by a high degree of electrical safety for the user. However, in special cases, further increasing the scope of protective measures may be necessary. The following measures are advised for this purpose:

- Use of RCDs:
If more than one load is connected simultaneously to the instagrid ONE max (e.g. via a power strip), then connecting an RCD (Residual Current Device) upstream for each load is recommended.

- **Restricted extension of the cable network:**
Generally speaking, the use of cable extensions or distributors on the instagrid ONE max is possible without any problems. However, considering the two points outlined below, opting for an overall expansion of the cable network that is as low as possible is advisable:
 - In order to ensure rapid tripping (<100 ms) of the electronic fuse of the outlet [section 3.2] in the event of a short circuit, the wire resistance between the instagrid ONE max and loads must not exceed a value of 1.5 Ω . A wire with a cross-section of 1.5 mm² achieves this resistance at a length of approx. 60 metres (including live and neutral conductors; excluding contact resistances at plug connections).
 - When the overall length of the cable network increases, its clarity is reduced. The probability of discovering a cable damaged in operation which could result in an earthing at the outlet of the instagrid ONE max reduces correspondingly.
- **Regular electrical checks of the loads used:**
If an electrical device is used mainly in an IT (isolé-terre) network, the probability of discovering insulation faults is reduced. For this reason, regular checks of the loads used (as required by DGUV V3 [German Accident Prevention Regulation 3]) by an electrical specialist are imperative.

3.4 Passive protection at the inlet

The charging inlet [8] is protected from overload by a fuse, which can be replaced by the user; see [section 7.1].

4. INITIAL COMMISSIONING

Before putting the device to use for the first time, carry out the following steps:

- Check the package for external damage.

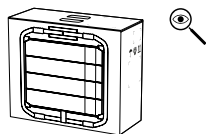

- Open the package at the top.

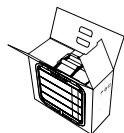

- Take out the instagrid ONE max by the handle together with the side cushion.

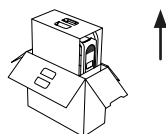

- Check for completeness and damage.

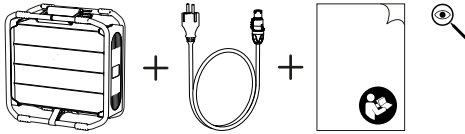



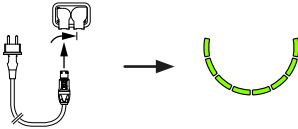

- Place the rotary switch [3] in the centre position .
- Connect the instagrid ONE max to the mains with the power cable. Wait until all the LEDs [5] display green lights continuously.

Note: the plug of the charging cable must first be connected to the instagrid ONE max and then turned clockwise until it noticeably latches in.





5. OPERATING STATES AND OPERATION

5.1 Concept of operation

By selecting one of the three possible positions  /  /  of the rotary switch [3], the user specifies the desired operating state. However, the actual operating state may differ from this, for example, if the switch is in the  position, but the instagrid ONE max is completely discharged. Use of the switch is described in detail in [\[section 5.2\]](#).

The instagrid ONE max tells you the actual operating state through eight LEDs [7]. The LEDs are also used to indicate warning and fault messages; see [\[section 6\]](#). The following characteristics must be noted:

- LEDs off: depending on the position of the rotary switch [3], the following possibilities arise.

Rotary switch	Charging inlet [8] connected to the mains	Meaning
	-	Device is in the operating state TRANSPORT [section 5.2.4]
	No	Device is in the operating state OFF [section 5.2.1]
	Yes	<ul style="list-style-type: none"> • Mains voltage not reaching the device. Possible causes: power outage, charging cable defective, input fuse [11] has tripped; see [section 7.1] • LED display possibly defective
	-	<ul style="list-style-type: none"> • Energy storage system completely discharged • A warning or fault has arisen during use in the DISCHARGE operating state; see [section 7] • LED display possibly defective

- LEDs show pulsing animation in white: the internal control electronics are conducting a start process with self-diagnostics functionality
- One or more LEDs light up or flash yellow: WARNING, see [section 6.1]
- One or more LEDs light up or flash red: FAULT, see [section 6.2]
- In the CHARGE [section 5.2.2] and DISCHARGE [section 5.2.3] operating states, the current charge status of the instagrid ONE max is indicated through the number of LEDs continuously lit up green
- Each LED segment corresponds to a charge of 12.5%



5.2 Operating states

5.2.1 OFF



The instagrid ONE max is in the OFF state when the rotary switch is in the  position, the charging inlet is not connected to the mains and all LEDs [\[5\]](#) have gone out. In this state, the main storage unit is connected neither to the charging inlet [\[8\]](#) nor the outlet [\[4 | 9\]](#) and instead is in a standby mode, which is exited when the charging inlet is connected to the mains. Use this operating state if you do not want to supply a connected load with power for a short period of time.

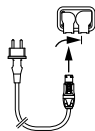

5.2.2 CHARGE



The instagrid ONE max is in the CHARGE state when the rotary switch is in the  position and the charging inlet is connected to the mains. The LEDs display a green-coloured progressive animation. In this state, the main storage unit is connected to the charging inlet [\[8\]](#), and the outlet [\[4 | 9\]](#) is voltage-free. Use this operating state when you want to recharge the instagrid ONE max after use, or to charge the instagrid ONE max prior to long-term storage; see [\[section 9.1\]](#).

Note: the plug of the charging cable must first be connected to the instagrid ONE max and then turned clockwise until it noticeably latches in.

Note: once all LEDs are continuously lit up green, the actual charging process ends, but the cells undergo a balancing program for another approx. 60 minutes. It is recommended that you disconnect the instagrid ONE max from the mains only once this time has lapsed.

Note: it is possible to connect the instagrid ONE max to the mains via the charging inlet provided the rotary switch [\[3\]](#) is still in the  position and to start the charging process at a time of your choice by placing the rotary switch in the .

5.2.3 DISCHARGE



The instagrid ONE max is in the DISCHARGE state when the rotary switch is in the **D** position and the main storage unit still has sufficient power to maintain operation of the instagrid ONE max in this state. In this operating state, the following characteristics of the LED display must be noted:

- If the LEDs go out after the start animation, the instagrid ONE max is fully discharged and must first be charged; see [\[section 5.2.2\]](#).
- In order to enable a precise indication of the charge state, the brightness of the highest-value LED currently active gradually changes from bright to dark as discharge progresses.
- This does not apply to the left LED. This lights up either with full brightness or flashes.
- If the left LED is flashing, the charge state of the instagrid ONE max is low. When combined with loads with a high power draw, in rare cases this may lead to a compromise to operating behaviour. Charge the instagrid ONE max timely; see [\[section 5.2.2\]](#).

The main storage unit is connected to the outlet of the instagrid ONE max. Even with the charging cable connected, the inlet and outlet are galvanically isolated; see [\[section 3.1\]](#). Use this operating state to supply a connected load with power. To do so, proceed as follows:

- Make sure that the load is switched off and is not connected to the instagrid ONE max.
- Set the instagrid ONE max to the DISCHARGE operating state.
- Connect the load to the outlet [\[4 | 9\]](#) of the instagrid ONE max.

5.2.4 TRANSPORT



The instagrid ONE max is in TRANSPORT mode when the rotary switch is in the **T** position and all LEDs [\[5\]](#) have gone out. There is no conductive electrical connection between the inlet [\[8\]](#), outlet [\[4 | 9\]](#) and the internal electronics. As a special feature, in this state, the internal energy storage system is completely inactive

and split into individual battery modules with an energy content of less than 100 Wh, between which there is no conductive connection. In this mode, the starter battery [\[section 5.3.1\]](#) can be charged by connecting the charging inlet to the mains. Always use this operating state when you want to store [\[section 8.1\]](#) or transport [\[section 8.2\]](#) the instagrid ONE max.

5.3 Features

5.3.1 Starter battery

In addition to the actual energy storage system, the instagrid ONE max contains a starter battery, to which the user need not usually pay attention. Nonetheless, in consideration of subsection [9.1], the underlying functionality of it will be explained in brief. The starter battery is discharged when:

- The OFF operating state changes to CHARGE or DISCHARGE. The power required for starting the internal control electronics is supplied by the starter battery.
- The instagrid ONE max is in the OFF operating state. The instagrid ONE max can still be started after at least 6 months in the OFF operating state provided that the starter battery was fully charged to begin with.
- The instagrid ONE max is in TRANSPORT mode. The instagrid ONE max can still be started after at least 12 months in TRANSPORT mode provided that the starter battery was fully charged to begin with.

The starter battery is charged when:

-

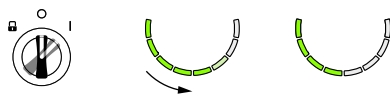

The instagrid ONE max is in the CHARGE or DISCHARGE operating states. You can expect an empty starter battery to be fully charged after approx. 12 hours.

-



The instagrid ONE max is in TRANSPORT mode and the charging inlet is connected to the mains. You can expect an empty starter battery to be fully charged after approx. 5 hours.



6. WARNINGS AND FAULTS

Due to external or internal influences, conditions may arise when starting or operating the instagrid ONE max that render the further use of the instagrid ONE max impossible; e.g. because of a defect that is present, or because continued operation (without conditions being changed) could lead to damage to the instagrid ONE max. If such a case occurs, the current operating state of the instagrid ONE max is exited – inlet [8] and outlet [4 | 9] are deactivated, the LEDs [5] light up or flash yellow or red.

Note: if a warning or fault message occurs when the instagrid ONE max is not in the CHARGE operating state, the LED display goes out after 60 minutes. Otherwise, the displaying of the message can be observed as long as the charging inlet [8] is connected to the mains.

6.1 Warning



Depending on the charge state of the instagrid ONE max, one or more LEDs [5] light up [section 6.1.1] or flash [section 6.1.2] yellow. A warning is acknowledged by placing the rotary switch [3] for at least 1 s in the  position and then in the  /  position corresponding to the desired operating state.

6.1.1 External problems

External circumstances prevent the useful operation of the instagrid ONE max. This state is indicated by the LEDs lighting up yellow. Examples of such situations are:

- Due to an overload of the outlet [4 | 9] in the DISCHARGE operating state, the electronic fuse has tripped; see [section 3.2].
- The AC inlet [8] of the instagrid ONE max is connected to the mains and the rotary switch [3] is in the  position, but an inadequate quality of mains supply is preventing operation in the CHARGE state.

6.1.2 Temperature problems

This state is indicated by the LEDs flashing yellow. Depending on the situation, the instagrid ONE max must be placed in a warmer or cooler location to continue operation. A reduction to the load at the outlet can also slow down further heating if the instagrid ONE max is in the DISCHARGE operating state.

6.2 Faults



Depending on the charge state of the instagrid ONE max, one or more LEDs [5] flash red. There is an internal malfunction that can only be rectified by authorised specialist personnel. Contact instagrid [section 10].

7. SERVICE AND MAINTENANCE

In normal operation, the instagrid ONE max works maintenance and servicing-free. With the exception of the input fuse [11] and the frame [7], the instagrid ONE max does not contain any components or assemblies that the user needs to replace or service.



ATTENTION!

If the instagrid ONE max has damage unrelated to the frame [7], a repair must be performed by authorised specialist personnel. Do not open the instagrid ONE max. Under no circumstances should you put the instagrid ONE max in operation. Activate TRANSPORT mode [section 5.2.4] by moving the rotary switch [3] to the  position and remove connected cables and/or loads. Contact instagrid, see [section 10].

7.1 Replacing the charging inlet fuse



A blown input fuse [11] may indicate a more serious underlying problem that cannot be rectified by replacing the fuse. Before replacing the fuse, activate TRANSPORT mode [section 5.2.4] by moving the rotary switch [3] to the  position and remove connected cables and/or loads. Open/close the fuse holder using a suitable screwdriver.



ATTENTION!

Only replace the fuse with an identical type (250 V T5A L):

- Rated voltage: 250 V
- Type: slow-blow (T)
- Rated current: 5 A
- Breaking capacity: low (L)
- Design: 5 × 20 mm
- Possible type: Littelfuse 0218005.MXP

7.2 Replacing the frame

The frame [7] of the instagrid ONE max can be replaced by the user in the event of damage. Corresponding spare parts and detailed instructions can be procured from instagrid; see [section 10].

8. MISCELLANEOUS

8.1 Storage

Before storage, activate TRANSPORT mode [section 5.2.4] by moving the rotary switch [3] to the  position and remove connected cables and/or loads.

Do not store the instagrid ONE max for long periods of time in a discharged state. This could lead to a deep discharge of the instagrid ONE max and necessitate recommissioning by instagrid.

In order to prevent a deep discharge of the starter battery [section 5.3.1] during long-term storage, it is advisable to fully charge the instagrid ONE max prior to storage and then to leave it connected to the mains for another four hours in TRANSPORT mode.

Charge the instagrid ONE max at least every 12 months.

For a long service life, store the instagrid ONE max at temperatures of between 0°C and 23°C in an atmosphere with low humidity.

8.2 Transport and shipping

"Transport" refers to any change of location of the instagrid ONE max, including shipping.

Observe the additional notes on transport in our transport instructions, of which you can find the latest version on our website: <https://instagrid.co/manuals>.

The integrated Li-Ion batteries are subject to the requirements of hazardous goods legislation. Relevant national and international regulations must be complied with.



Before transport, activate TRANSPORT mode [section 5.2.4] by moving the rotary switch [3] to the  position and remove connected cables and/or loads.

Make sure that the operating state of the instagrid ONE max does not change during transport. The instagrid ONE max may only be transported in an undamaged condition. Additional rules of the shipping service provider must be heeded.

If a return shipment is necessary due to a defect or a malfunction, contact instagrid; see [section 10].

8.3 Cleaning and care



Before cleaning, activate TRANSPORT mode [section 5.2.4] by moving the rotary switch [3] to the  position and remove connected cables and/or loads.

Close the socket covers [8 | 9].

Check the instagrid ONE max for damage.

Wet cleaning of the instagrid ONE max is permitted. However, when doing this, you must ensure that no water jets are used; in particular, the use of pressure washers is not permitted.

The use of solvents or other strongly reactive chemicals is not permitted.

9. MANUFACTURER'S DECLARATION

9.1 Declaration of conformity

 It is hereby confirmed that the product instagrid ONE max from the manufacturer instagrid GmbH meets the requirements of the applicable EU directives, including all relevant amendments. This declaration loses its validity once modifications of electromechanical relevance are made to the device. A detailed declaration of conformity can be downloaded here: <https://instagrid.co/manuals>.

9.2 WEEE declaration / disposal

 The instagrid ONE max is marked with the symbol of the crossed-out refuse bin. This means that the instagrid ONE max must not be disposed of with domestic waste in line with the EU directives governing waste electrical and electronic equipment and batteries, as well as those directives' transposition into national law. At the end of the service life, the used instagrid ONE max should be handed over to authorised collection points, ideally discharged. Heed the regulations governing environmentally friendly disposal that apply in your area. The integrated battery modules must only be removed from the instagrid ONE max by a qualified specialist. The chemical contents of batteries can cause harm to health and the environment and lead to fires and explosions when stored and disposed of improperly.

9.3 Licences and copyrights

You can find information regarding licences and copyrights here: <https://instagrid.co/manuals>.

10. CONTACT

10.1 General enquiries

hello@instagrid.co
<https://instagrid.co>
+49 (0)71 4169 6240

10.2 In case of damage or repair

support@instagrid.co
+49 (0)71 416 962 410

10.3 Address

instagrid GmbH
Hermann-Hagenmeyer-Straße 1
71636 Ludwigsburg
GERMANY



instagrid.co